

# Encapsulated Transformer

## EI-54x18.8mm Series

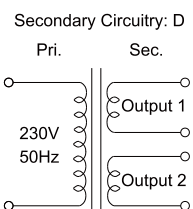
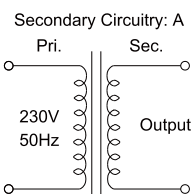
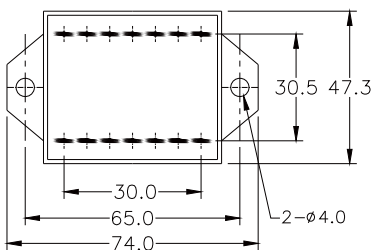
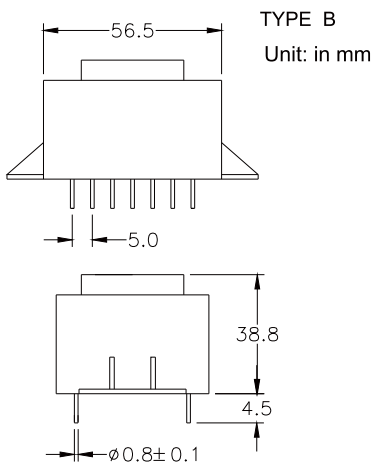
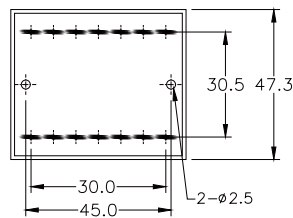
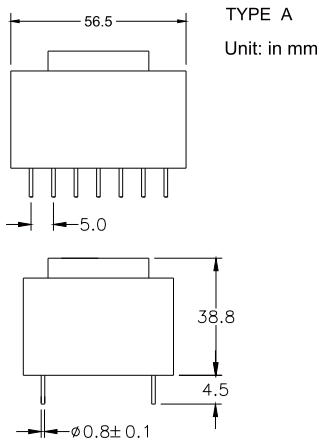

Catalog No	Secondary						Ambient Temp. (Ta)	Approval	
	Rated Voltage	Power Rating	Loading Current	No-Load Voltage	Secondary Circuit	Secondary Fuse		VDE	CE
V54AJ-19A1P7	6.0 V	16.0 VA	2.67 Amp	7.4 V	A	2750 mA	70°C	○	●
V54AJ-19A2P5	6.0 V	16.0 VA	2.67 Amp	7.2 V	A	2500 mA	50°C	○	●
V54AJ-19A2P7	7.5 V	16.0 VA	2.13 Amp	9.7 V	A	2500 mA	70°C	○	●
V54AJ-19A1P5	9.0 V	16.0 VA	1.78 Amp	10.5 V	A	2000 mA	50°C	○	●
V54AJ-19A3P7	9.0 V	16.0 VA	1.78 Amp	11.1 V	A	2000 mA	70°C	○	●
V54AJ-19A3P5	12.0 V	16.0 VA	1.33 Amp	14.5 V	A	1250 mA	50°C	○	●
V54AJ-19A4P7	12.0 V	16.0 VA	1.33 Amp	14.7 V	A	1250 mA	70°C	○	●
V54AJ-19A4P5	15.0 V	16.0 VA	1.07 Amp	17.8 V	A	1000 mA	50°C	○	●
V54AJ-19A5P7	15.0 V	16.0 VA	1.07 Amp	18.4 V	A	1000 mA	70°C	○	●
V54AJ-19A5P5	18.0 V	16.0 VA	0.89 Amp	21.5 V	A	1000 mA	50°C	○	●
V54AJ-19A6P7	18.0 V	16.0 VA	0.89 Amp	22.1 V	A	1000 mA	70°C	○	●
V54AJ-19A6P5	24.0 V	16.0 VA	0.67 Amp	28.5 V	A	630 mA	50°C	○	●
V54AJ-19A7P7	24.0 V	16.0 VA	0.67 Amp	29.3 V	A	630 mA	70°C	○	●

Catalog No	Secondary						Ambient Temp. (Ta)	Approval	
	Rated Voltage	Power Rating	Loading Current	No-Load Voltage	Secondary Circuitry	Secondary Fuse		VDE	CE
V54AJ-19D1P7	6.0 Vx2	16.0 VA	1.33 Amp	7.4 Vx2	D	1500 mA	70°C	○	●
V54AJ-19D2P5	6.0 Vx2	16.0 VA	1.33 Amp	7.2 Vx2	D	1250 mA	50°C	○	●
V54AJ-19D2P7	7.5 Vx2	16.0 VA	1.07 Amp	9.7 Vx2	D	1250 mA	70°C	○	●
V54AJ-19D3P5	9.0 Vx2	16.0 VA	0.89 Amp	10.8 Vx2	D	1000 mA	50°C	○	●
V54AJ-19D3P7	9.0 Vx2	16.0 VA	0.89 Amp	11.1 Vx2	D	1000 mA	70°C	○	●
V54AJ-19D4P5	12.0 Vx2	16.0 VA	0.67 Amp	14.3 Vx2	D	630 mA	50°C	○	●
V54AJ-19D4P7	12.0 Vx2	16.0 VA	0.67 Amp	14.7 Vx2	D	630 mA	70°C	○	●
V54AJ-19D5P5	15.0 Vx2	16.0 VA	0.53 Amp	19.5 Vx2	D	500 mA	50°C	○	●
V54AJ-19D5P7	15.0 Vx2	16.0 VA	0.53 Amp	18.4 Vx2	D	500 mA	70°C	○	●
V54AJ-19D1P5	18.0 Vx2	16.0 VA	0.44 Amp	21.4 Vx2	D	500 mA	50°C	○	●
V54AJ-19D6P7	18.0 Vx2	16.0 VA	0.44 Amp	22.0 Vx2	D	500 mA	70°C	○	●
V54AJ-19D7P7*	24.0 Vx2	16.0 VA	0.33 Amp	29.3 Vx2	D	315 mA	70°C	○	●

**Remarks :**

**1) Catalog Number System :**

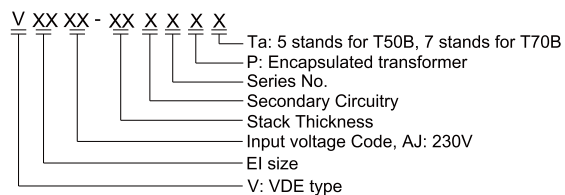

2) Non short-circuit proof safety isolating transformer

3) \* - Non short-circuit proof isolating transformer

4) Temperature Class : B

5) Weight per unit : approximate 430gm

6) ● - Approved

7) ○ - Meet Standard